



Micros cleat range Nylon and Aluminium

- Small, neat and lightweight for 1- 4mm $3/64''$ - $5/32''$ rope.
- Advanced tooth technology to hold all types of small rope.
- Can be fixed with standard screws and rivets, on tubular or flat surfaces.

Some Applications - Window blinds (cord control). Canoes (seat & rudder lines). Control lines on dinghies (Optimist booms & carbon tillers). Kitesurfing (5th line adjustment).

Open Cleat



Available soon

Aluminium or Nylon

Aluminium or Nylon.
Compact to fit into small locations.
Ideal when a rope is not always cleated.

Fairlead Cleat



Aluminium or Nylon

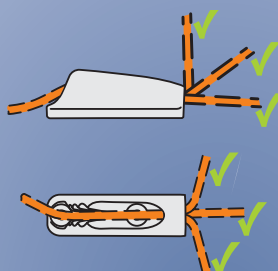

Fairlead strengthens cleat and allows quick fine adjustments of the rope.
Helps hold rope into teeth when a line is flogging.



Fairlead Cleat with Becket

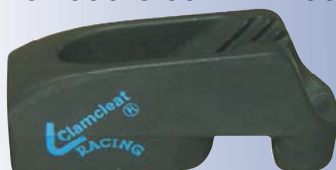

Aluminium only

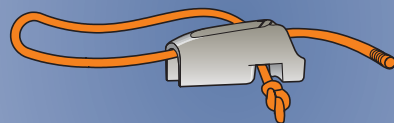

Large Becket makes it easy for frequent de-rigging.



Side entry Cleat with Becket

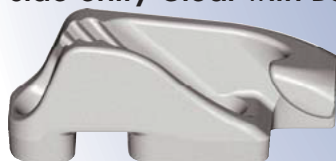

Aluminium only

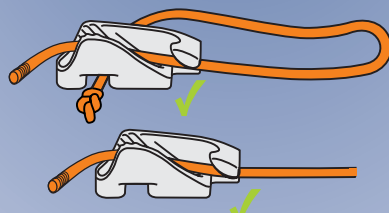

Side entry cleats gives the benefit of a fairlead but use of temporary cleating.



Tapered Pad allows correct rope/cleating alignment.
Cleats can be mounted either way round.
Pads can be stacked to increase angle or create a riser block.

Backplate provides support on thin deck sections.

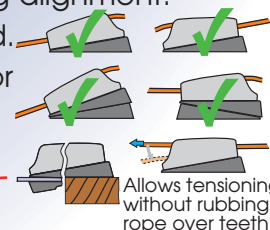

Clamcleats Limited Watchmead Welwyn Garden City Hertfordshire AL7 1AP England
Telephone 01707 330101 Fax 01707 321269 e-mail sales@clamcleat.com
www.clamcleat.com

Schiffsausrüster

TOPLICHT

Tel.: +49 (0)40 - 88 90 100

www.toplicht.de

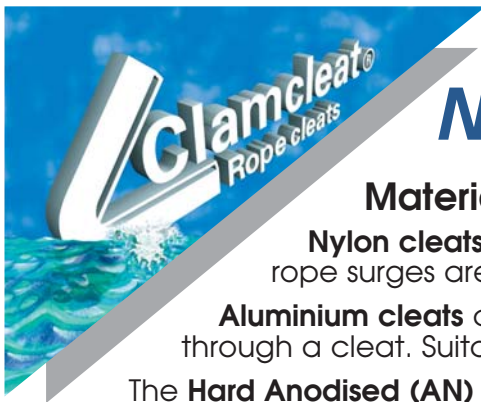

Micros cleat range Nylon and Aluminium

Material Selection

Nylon cleats offer very good value for money and are ideal where high loads or rope surges are not likely to be encountered.

Aluminium cleats are unaffected by the heat generated by a rope surging back through a cleat. Suitable for sub-zero temperatures. Good corrosion resistance.

The **Hard Anodised (AN)** finish gives a high-tech and fashionable appearance as well as offering superior resistance to sea water corrosion.

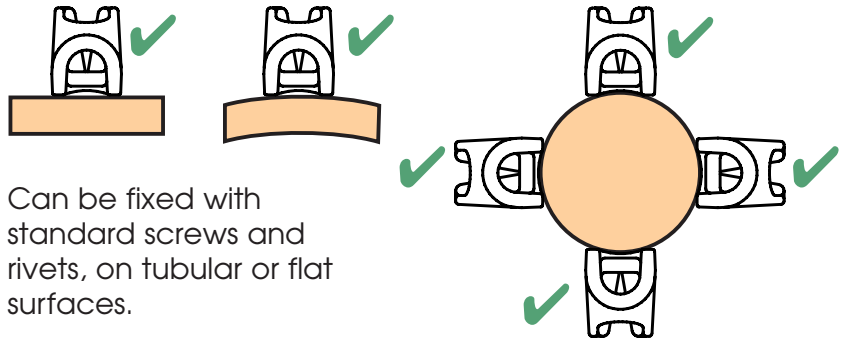

Can be fixed with standard screws and rivets, on tubular or flat surfaces.

Cleats for ropes to 4mm (5/32")

	mm Ø inch Ø	A B C	mm inch	mm Ø inch Ø	mm Ø inch Ø	mm Ø Gauge	Gms Ozs
CL263 & CL263W White Micros	1 - 4	Nylon A44 B24 C13	3.2	#4	3	5	
	3/64-5/32	A13/4 B15/16 C1/2	1/8	1/8	No4	0.2	
CL268 & CL268AN Hard Anodised Racing Micros	1 - 4	Aluminium A44 B24 C13	3.2	#4	3	11	
	3/64-5/32	A13/4 B15/16 C1/2	1/8	1/8	No4	0.4	
CL270 & CL270AN Hard Anodised Racing Micros with Becket	1 - 4	Aluminium A44 B24 C13	3.2	#4	3	13	
	3/64-5/32	A13/4 B15/16 C1/2	1/8	1/8	No4	0.5	
CL274 & CL274W Open Micros	-	Nylon A33 B24 C13	3.2	#4	3	3	
	-	A15/16 B15/16 C1/2	1/8	1/8	No4	0.1	
CL275 & CL275AN Open Racing Micros	-	Aluminium A33 B24 C13	3.2	#4	3	7	
	-	A15/16 B15/16 C1/2	1/8	1/8	No4	0.25	
CL277 & CL277AN Hard Anodised Side entry Racing Micros with Becket (Starboard)	1 - 4	Aluminium A44 B24 C14	3.2	#4	3	11	
	3/64-5/32	A13/4 B15/16 C9/16	1/8	1/8	No4	0.4	
CL278 & CL278AN Hard Anodised Side entry Racing Micros with Becket (Port)	1 - 4	Aluminium A44 B24 C14	3.2	#4	3	11	
	3/64-5/32	A13/4 B15/16 C9/16	1/8	1/8	No4	0.4	
CL823 Tapered Pad for CL263, CL268, CL270, CL277 & CL278	-	Polypropylene A47 B - C19	3.2	#4	3	4	
	-	A113/16 B - C3/4	1/8	1/8	No4	0.15	

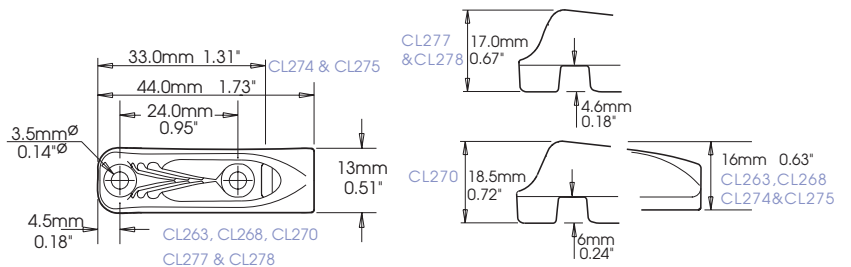



Mk2 Junior cleat range Nylon and Aluminium

- Small, neat and lightweight for 3 - 6mm 1/8" - 1/4" rope.
- Advanced tooth technology to hold all types of small rope.
- Can be fixed with standard screws and rivets, on tubular or flat surfaces.

Some Applications - Window blinds (cord control). Canoes (seat & rudder lines). Control lines on dinghies. Kitesurfing (Brake Line adjustment).

Open Cleat



Aluminium or Nylon

Compact to fit into small locations. Ideal when a rope is not always cleated.

Fairlead Cleat



Aluminium or Nylon

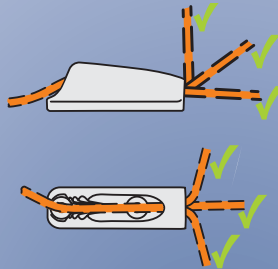

Fairlead strengthens cleat and allows quick fine adjustments of the rope. Helps hold rope into teeth when a line is flogging.

Fairlead Cleat with Becket



Aluminium only

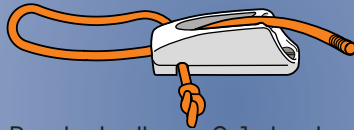

Becket allows 2:1 rigging.

Side entry Cleat



Aluminium only

1. Rope runs free
Keeper is closed to stop rope going into cleat teeth

2. Pull rope back and down to cleat
Keeper opens to allow rope into teeth

3. Rope gripped
Keeper holds rope in cleat

4. Lift up to release
Keeper opens to allow rope out of teeth

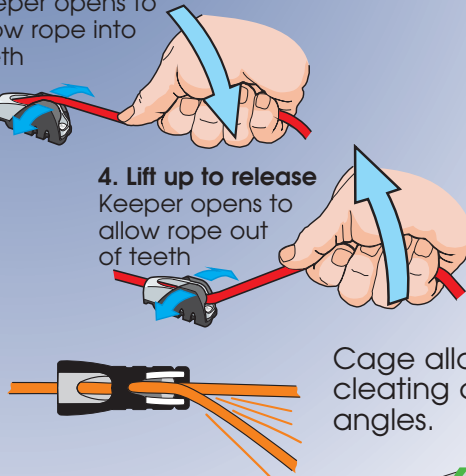

Cage allows easy cleating at extreme angles.

Tapered Pad allows correct alignment. Cleats can be mounted either way round. Backplate provides support on thin deck sections.

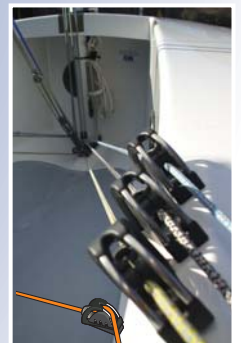
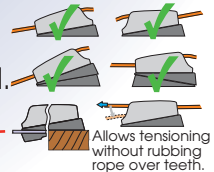

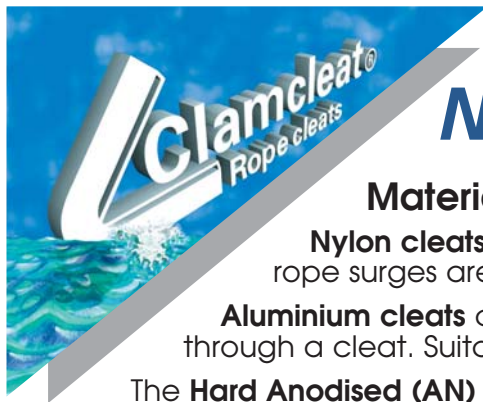

Mk2 Junior cleat range Nylon and Aluminium

Material Selection

Nylon cleats offer very good value for money and are ideal where high loads or rope surges are not likely to be encountered.

Aluminium cleats are unaffected by the heat generated by a rope surging back through a cleat. Suitable for sub-zero temperatures. Good corrosion resistance.

The **Hard Anodised (AN)** finish gives a high-tech and fashionable appearance as well as offering superior resistance to sea water corrosion.



CL204

CL204W



CL222

CL222AN



CL272

CL272W

Available soon



CL211Mk2

CL211Mk2AN



CL211Mk2/S2

CL211Mk2/S2AN



CL217Mk2AN

CL217Mk2



CL218Mk2



CL218Mk2AN

CL815



CL817



CL819

CL802

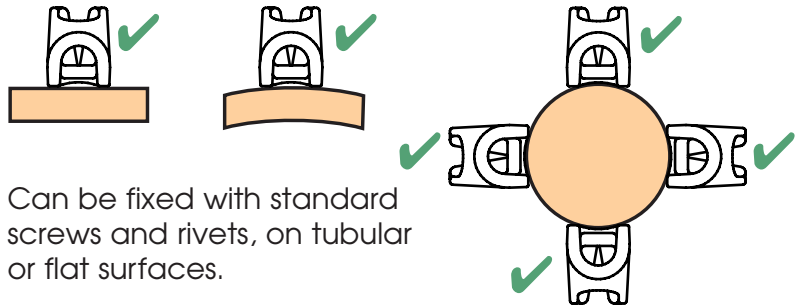

Can be fixed with standard screws and rivets, on tubular or flat surfaces.

Cleats for ropes to 6mm (1/4")

	mm Ø inch Ø	A B	C	mm inch	mm Ø inch Ø	mm Ø inch Ø	mm Ø Gauge	Gms Ozs
CL204 & CL204W White Mini	3 - 6 1/8-1/4	Nylon A52 B36 C17	A2 1/16 B17/16 C11/16	3.2 1/8	#8 4	4.2 No8	9 0.3	
CL211 Mk2 & CL211 Mk2AN Hard Anodised Racing Junior Mk2	3 - 6 1/8-1/4	Aluminium A55 B27 C17	A2 1/8 B11/16 C11/16	3.2 1/8	#8 4	4.2 No8	21 0.8	
CL211Mk2/S2 & CL211Mk2AN/S2 Hard Anodised Racing Junior Mk2 with Becket	3 - 6 1/8-1/4	Aluminium A55 B27 C17	A2 1/8 B11/16 C11/16	3.2 1/8	#8 4	4.2 No8	21 0.8	
CL217 Mk2 & CL217 Mk2AN Hard Anodised Side entry (Starboard)	3 - 6 1/8-1/4	Aluminium A55 B27 C17	A2 1/8 B11/16 C11/16	3.2 1/8	#8 4	4.2 No8	24 0.8	
CL218 Mk2 & CL218 Mk2AN Hard Anodised Side entry (Port)	3 - 6 1/8-1/4	Aluminium A55 B27 C17	A2 1/8 B11/16 C11/16	3.2 1/8	#8 4	4.2 No8	24 0.8	
CL222 & CL222AN Hard Anodised Racing Mini	3 - 6 1/8-1/4	Aluminium A48 B36 C15	A1 7/8 B17/16 C5/8	3.2 1/8	#8 4	4.2 No8	16 0.6	
CL272 & CL272W White Nylon Mk2 Junior	3 - 6 1/8-1/4	Nylon A55 B27 C17	A2 1/8 B11/16 C11/16	3.2 1/8	#8 4	4.2 No8	12 0.4	
CL815 Keeper for CL211 Mk2, CL211 Mk2AN, Mk2/S2, CL211 Mk2AN/S2 & CL272	3 - 6 1/8-1/4	Acetal A - B - C -	-	3.2 1/8	#8 4	4.2 No8	9 0.3	
CL817 Cage for CL211 Mk2, CL211 Mk2AN & CL272	-	Nylon & Stainless steel A - B - C -	-	-	-	-	23 0.8	
Requires CL815 Keeper	-	-	-	-	-	-	-	
CL802 Tapered Pad for CL204 & CL222	3 - 6 1/8-1/4	Polypropylene A 57 B - C21	A2 1/4 B - C13/16	3.2 1/8	#8 4	4.2 No8	4 0.1	
CL819 Tapered Pad for CL211 Mk2, CL217 Mk2, CL218 Mk2, CL211 Mk2/S2 & CL272	3 - 6 1/8-1/4	Polypropylene A60 B27 C23	A2 3/8 B11/16 C29/32	3.2 1/8	#8 4	4.2 No8	8 0.3	

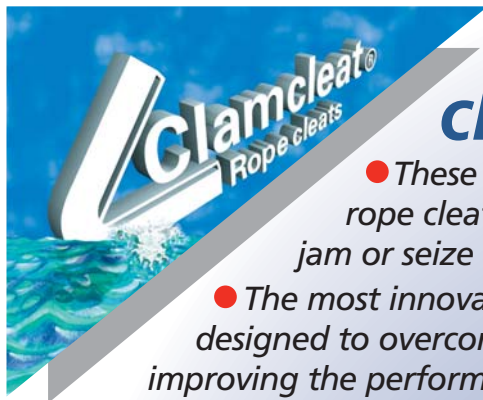

Accessories improve cleat performance

- These accessories expand the capability of a conventional Clamcleat® rope cleat while retaining the advantage of not having any moving parts to jam or seize up.
- The most innovative accessory is the Keeper (patent pending). This has been designed to overcome the problem of lines being cleated accidentally as well as improving the performance of cleats by holding lightly-loaded lines in the jaws of a cleat.

Tapered Pad allows correct rope/cleating alignment.



Mount either way round.



Pads can be stacked to increase angle or create a riser block.

Backplate provides under deck support when bolting through thin sections. Supplied with every tapered pad.



Award winning **Keeper** automatically prevents unwanted cleating.

Lead-in allows easy cleating.

Holds rope in teeth under no load or when mounted upside down.

Drainage slots.

Mount on flat or curved surface.

Tested for thousands of cycles under harsh conditions.



Pull rope back and down to cleat

Lift up to release

Two full ranges

Cage allows easy cleating at extreme angles



Wear resistant stainless steel



Rope runs free - Keeper keeps rope out of teeth



Pull rope down to cleat. Sloping rear automatically guides rope into teeth

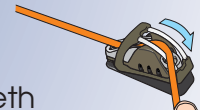

Rope held securely, even if cleat is mounted under a surface.

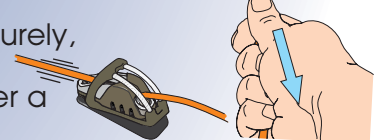

CL814	CL816	CL818	mm Ø inch Ø	mm Ø inch Ø	mm Ø Gauge	mm Ø inch Ø
CL814 Keeper for CL203, CL211 Mk1, CL211 Mk1AN, CL217 Mk1, CL218 Mk1, CL236 & CL236AN			3 - 6 1/8-1/4	4.8 3/16	4.8 / 5 No10	5 3/16 #10
CL816 Cage for CL203, CL211 Mk1, CL211 Mk1AN, CL236 & CL236AN Requires CL814 Keeper			-	-	-	-
CL818 Tapered Pad for CL203, CL211 Mk1, CL217 Mk1, CL218 Mk1, CL236, CL704 & CL704AN			3 - 6 1/8-1/4	4.8 3/16	4.8 / 5 No10	5 3/16 #10

CL815	CL817	CL819	mm Ø inch Ø	mm Ø inch Ø	mm Ø Gauge	mm Ø inch Ø
CL815 Keeper for CL211 Mk2, CL211 Mk2AN, CL211 Mk2/S2 & CL211 Mk2AN/S2			3 - 6 1/8-1/4	4 5/32	4 / 4.2 No8	4 5/32 #8
CL817 Cage for CL211 Mk2 & CL211 Mk2AN, Requires CL815 Keeper			-	-	-	-
CL819 Tapered Pad for CL211 Mk2, CL217 Mk2, CL218 Mk2 & CL211 Mk2/S2			3 - 6 1/8-1/4	4 5/32	4 / 4.2 No8	4 5/32 #8

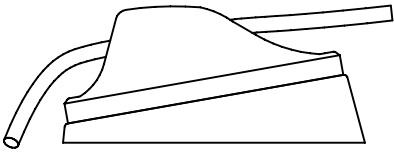

Application

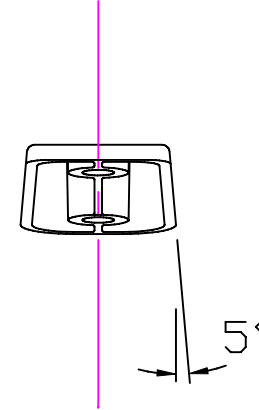
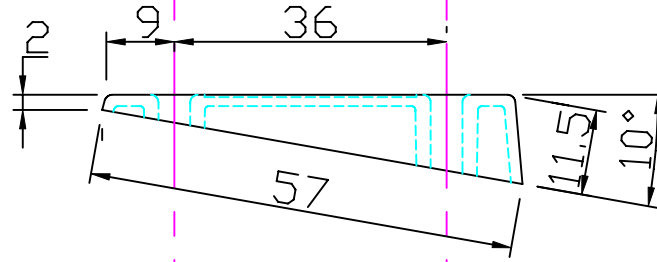
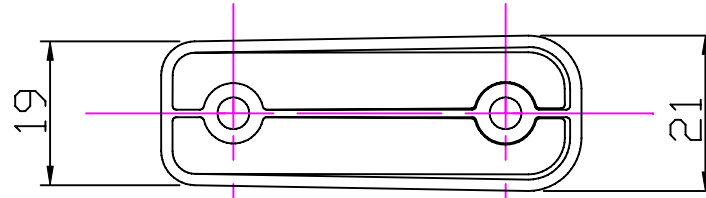

2 Holes $\phi 4.2$

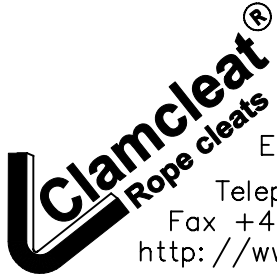
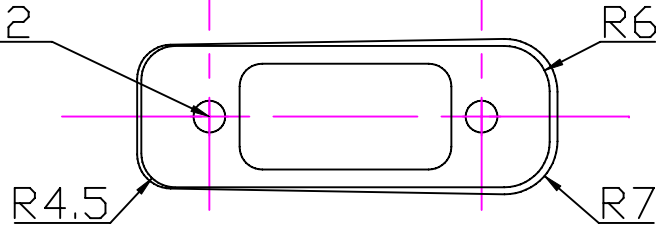

Clamcleats Limited
Watchmead
Welwyn Garden City
Hertfordshire AL7 1AP
England

Telephone +44 (0)1707 330101
Fax +44 (0)1707 321269
<http://www.clamcleat-rope-cleats.com>

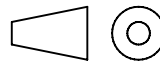

Scale 1:1
All dimensions in mm.

Issue: 3. May 2006
ID802.dwg

Material:
Polypropylene

Installation Drawing for:-
CL802
Tapered Pad
for CL204 & CL222

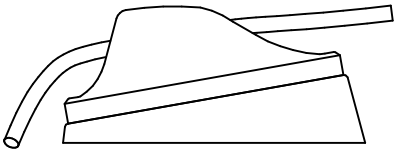

Application

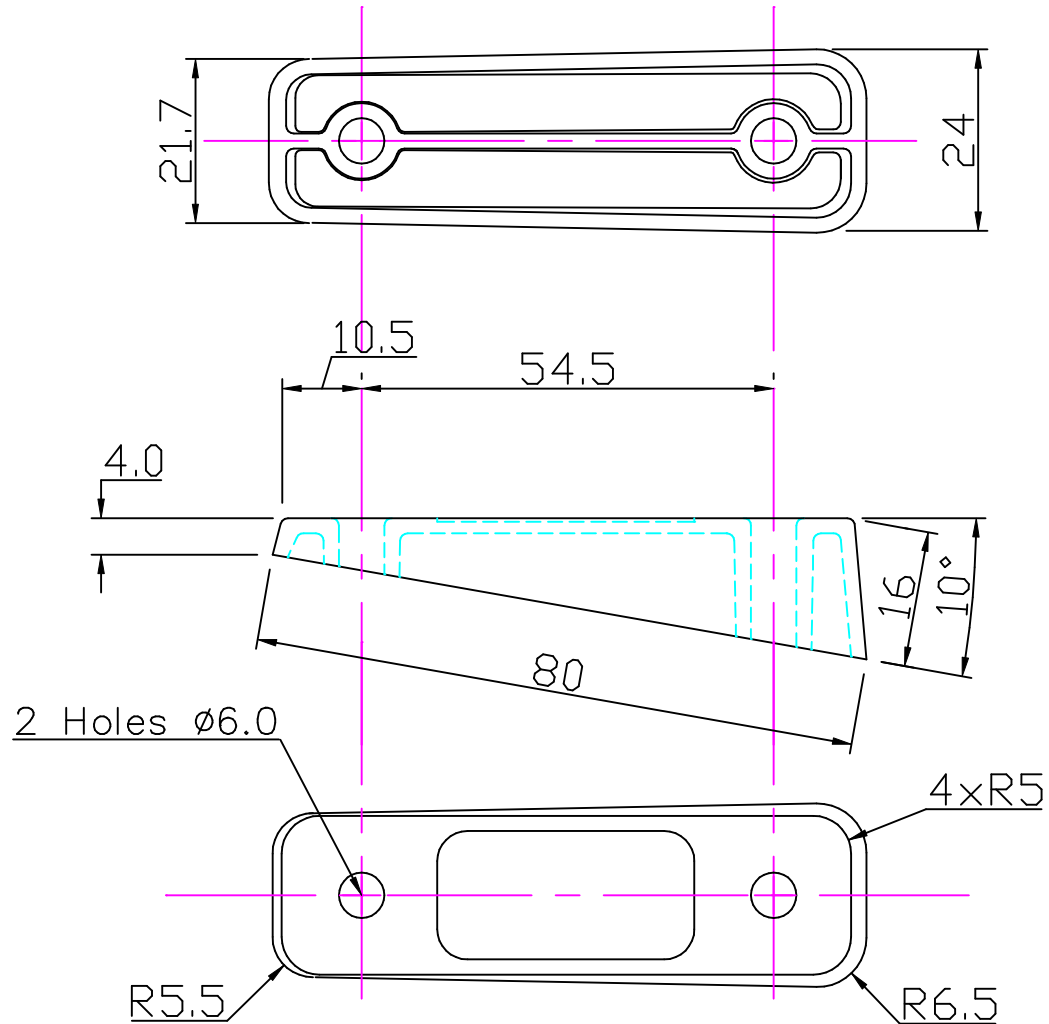

2 Holes $\phi 6.0$

4xR5

R5.5

R6.5

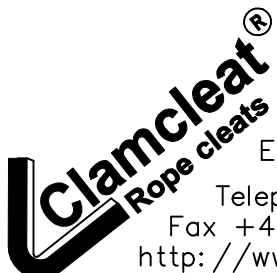

Clamcleats Limited
 Watchmead
 Welwyn Garden City
 Hertfordshire AL7 1AP
 England

Telephone +44 (0)1707 330101
 Fax +44 (0)1707 321269
<http://www.clamcleat-rope-cleats.com>



Scale 1:1
 All dimensions in mm.

Issue: 2. May 2002
 ID803.dwg

Material:
 Polypropolene

Installation Drawing for:-
CL803
 Tapered Pad
 for CL209 & CL254

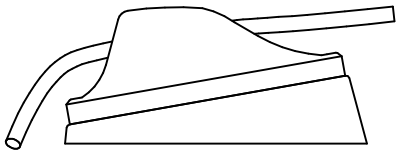

Application

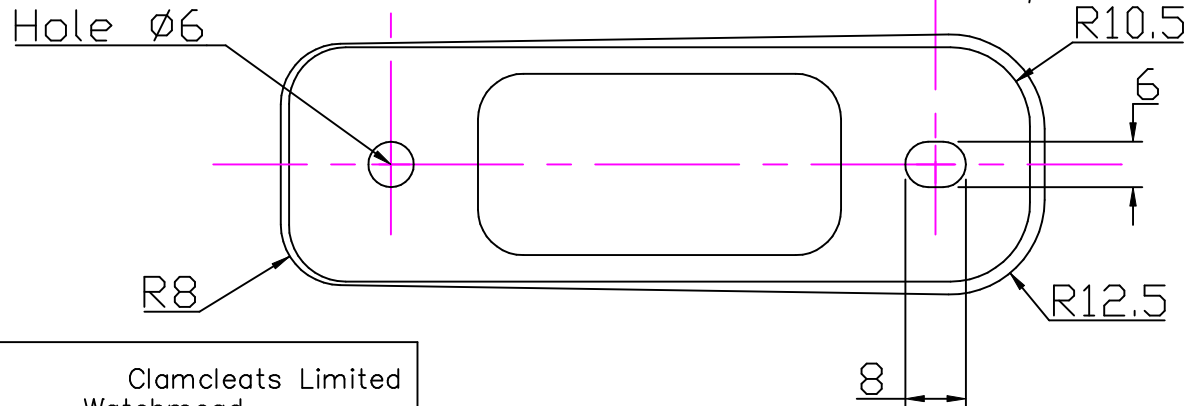
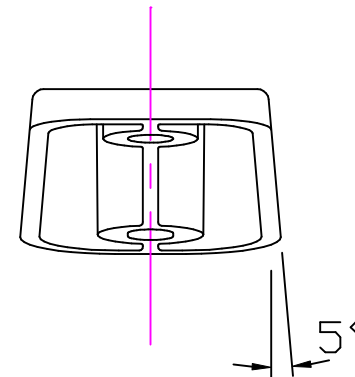
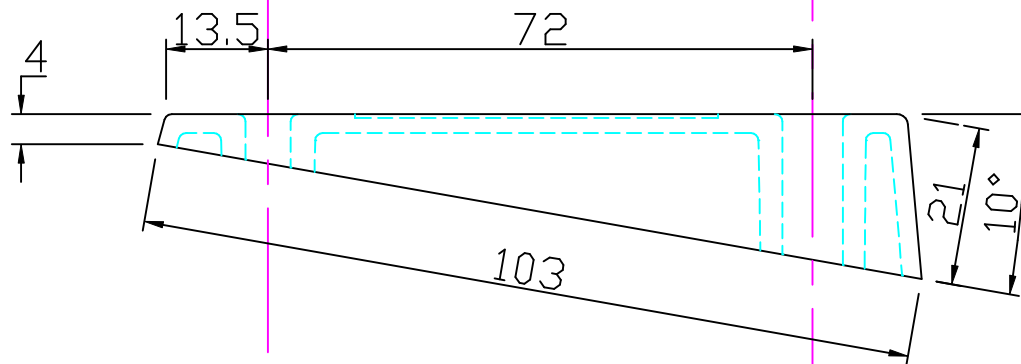
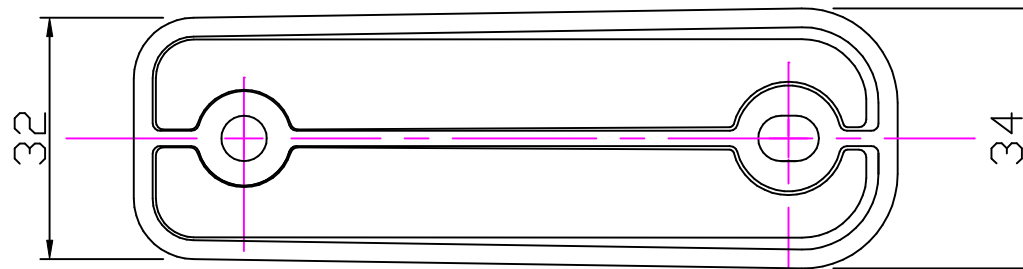

Clamcleats Limited
 Watchmead
 Welwyn Garden City
 Hertfordshire AL7 1AP
 England

Telephone +44 (0)1707 330101
 Fax +44 (0)1707 321269
<http://www.clamcleat-rope-cleats.com>



Scale 1:1
 All dimensions in mm.

Issue: 2. May 2002
 ID804.dwg

Material:
 Polypropylene

Installation Drawing for:-

CL804

Tapered Pad for CL201,
 CL219, CL237 & CL238

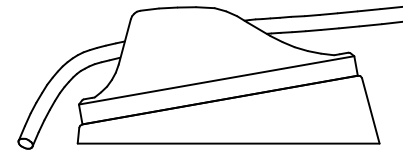
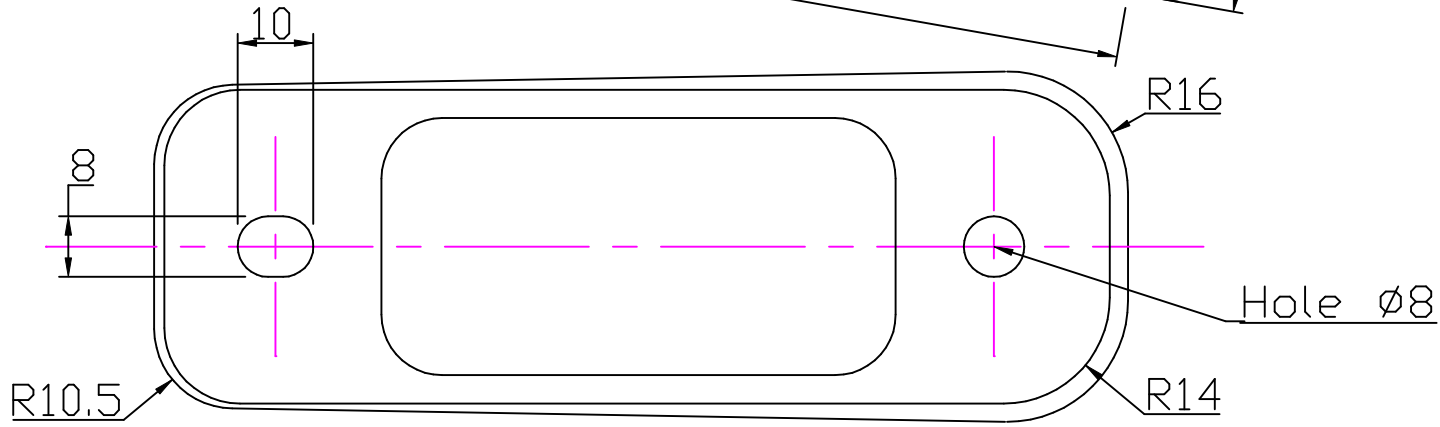
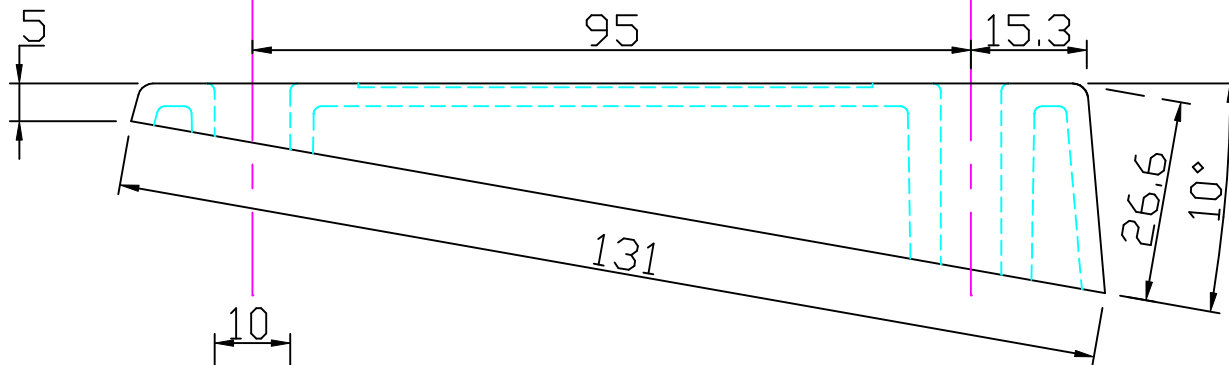
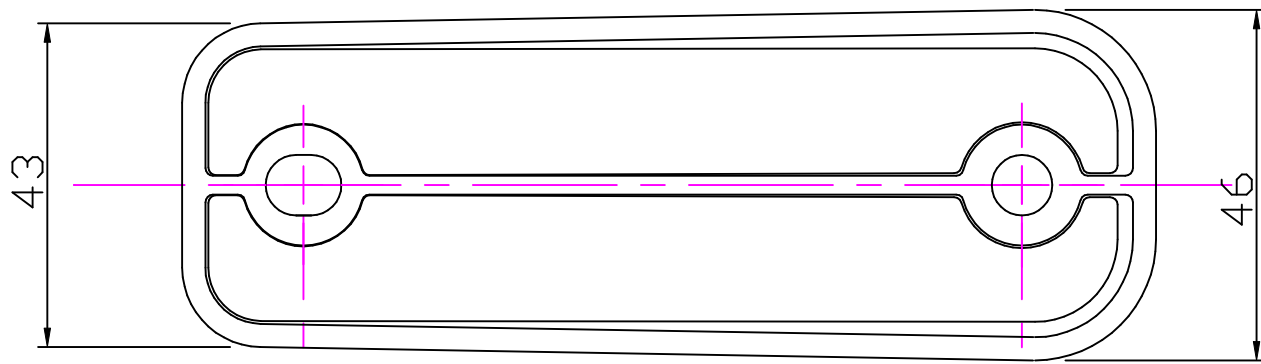

Application

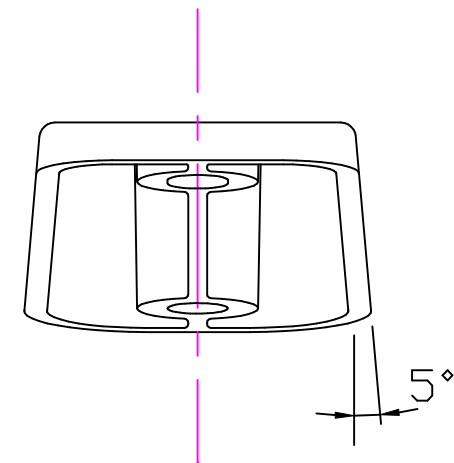

Clamcleat®
Rope cleats

Clamcleats Limited
Watchmead
Welwyn Garden City
Hertfordshire AL7 1AP
England

Telephone +44 (0)1707 330101
Fax +44 (0)1707 321269
<http://www.clamcleat-rope-cleats.com>

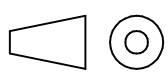

Scale 1:1
All dimensions in mm.

Issue: 2.	May 2002
ID805.dwg	
Material: Polypropylene	
Installation Drawing for:- CL805 Tapered Pad for CL205, CL220, CL239 & CL240	

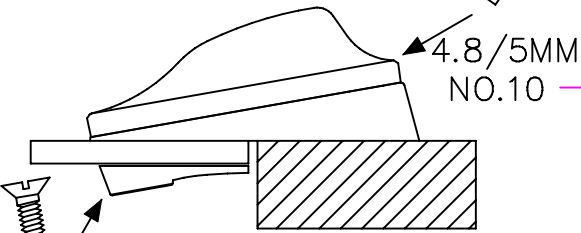
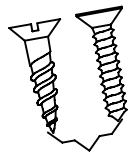
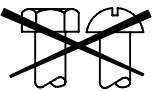

M5
#10_3/16"

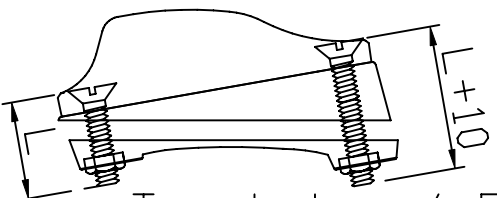
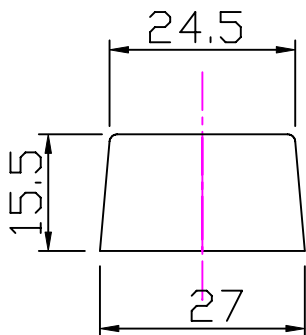

Two holes \varnothing 5.3x8.3

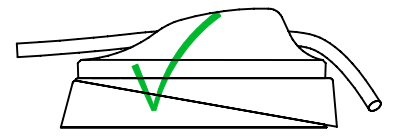
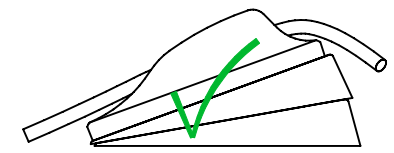
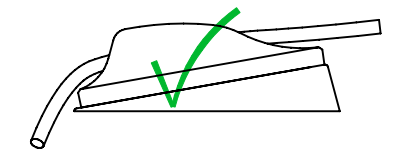
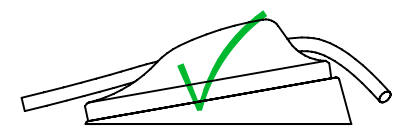
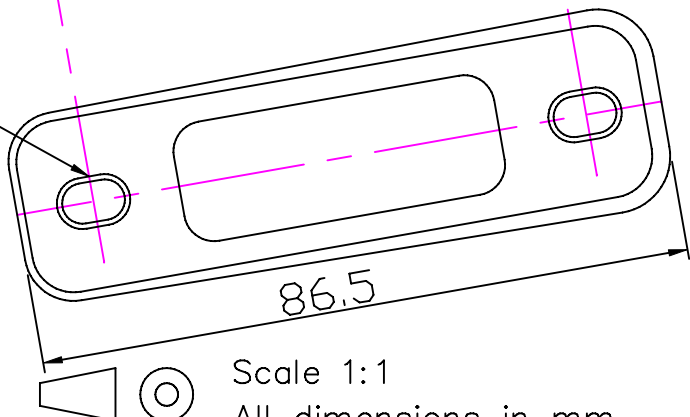
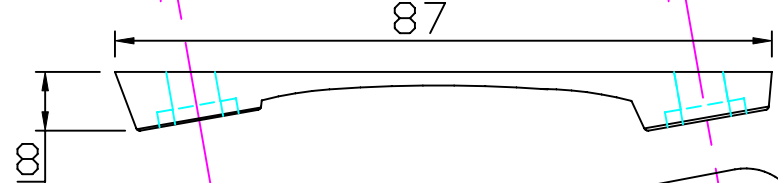
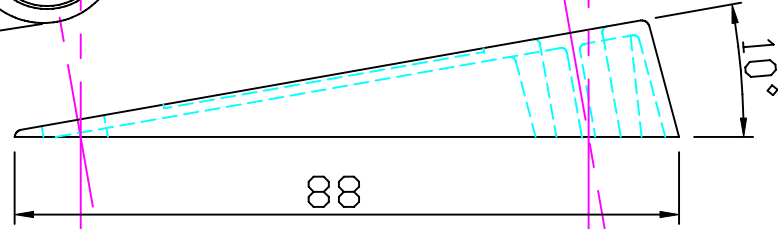
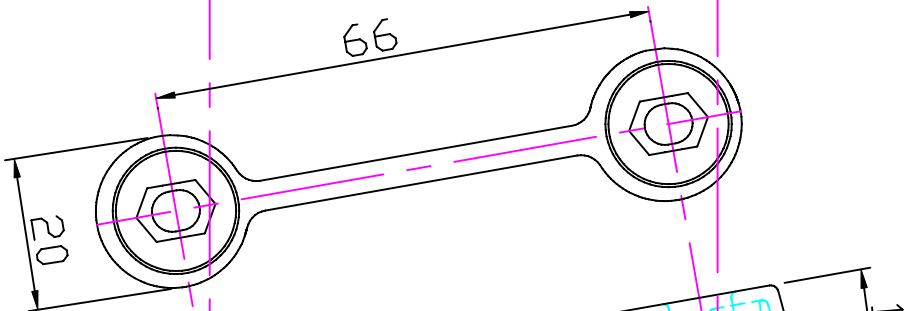
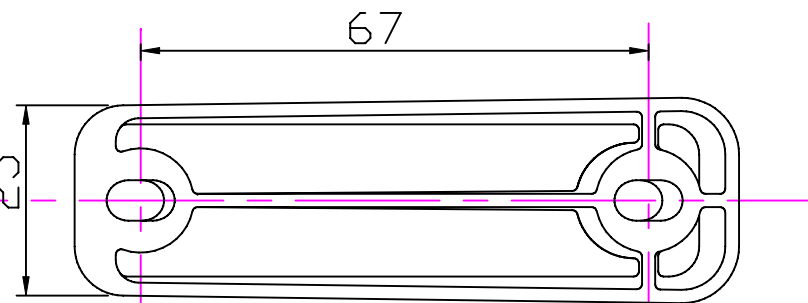

Clamcleats Limited
Watchmead
Welwyn Garden City
Hertfordshire AL7 1AP
England

Telephone +44 (0)1707 330101
Fax +44 (0)1707 321269
<http://www.clamcleat.com>

Scale 1:1
All dimensions in mm.

Issue: 2. May 2006
ID818.dwg

Material:
Polypropylene

Installation Drawing for: -
CL818
Tapered Pad for: CL203, CL211mk1,
CL211mk1AN, CL217mk1, CL218mk1,
CL236, CL236AN, CL704, CL704AN

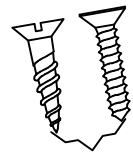
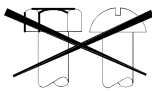

4/4.2MM
NO.8

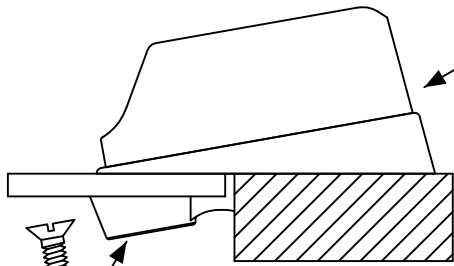

M4
#8_5/32"

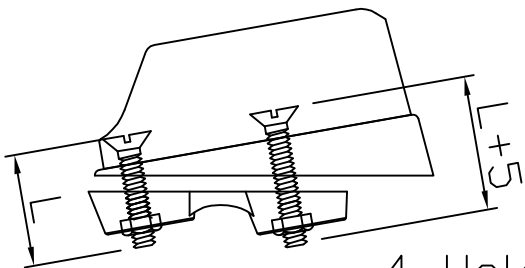
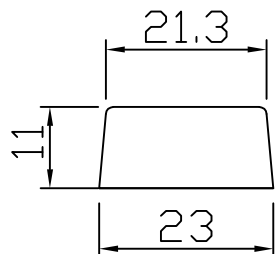

4 Holes $\phi 4.5 \times 5.5$

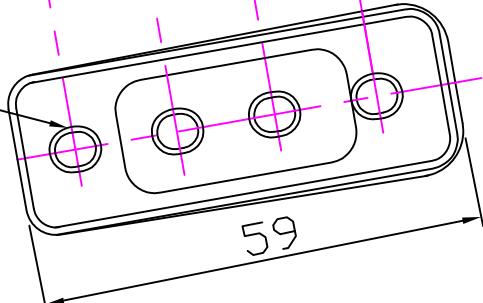
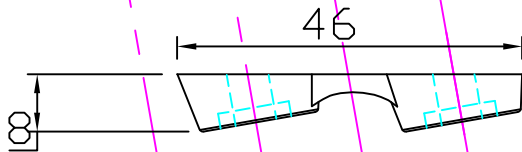
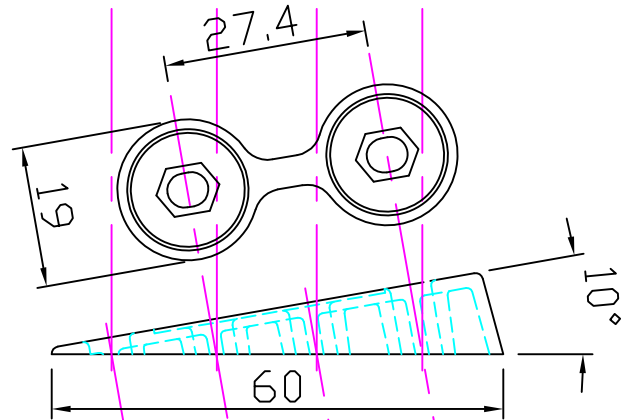
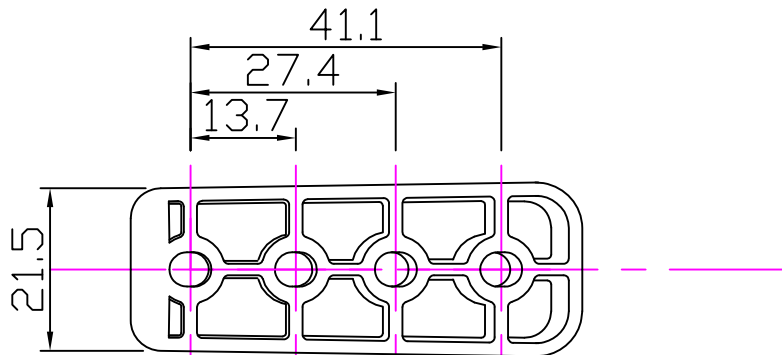

Scale 1:1
All dimensions in mm.

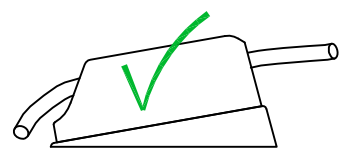
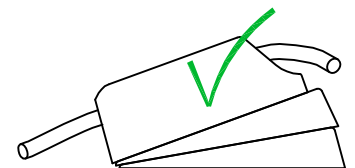
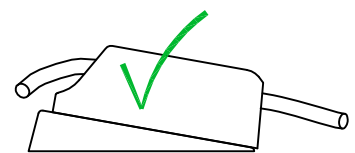
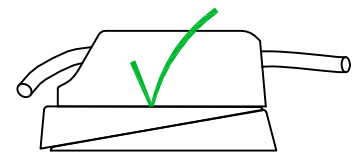

Clamcleat®
Rope cleats

Clamcleats Limited
Watchmead
Welwyn Garden City
Hertfordshire AL7 1AP
England

Telephone +44 (0)1707 330101
Fax +44 (0)1707 321269
Email sales@clamcleat.com
http://www.clamcleat.com

Issue: 3 Mar 2009
ID819.dwg

Material:
Polypropylene

Installation Drawing for:-
CL819
Tapered Pad for CL211mk2,
CL217mk2, CL218mk2