

For more info »
www.rocamarine.com/382020

P1 = EVENLY DISTRIBUTED LOAD
P2 = POINT LOAD

Rakego folding bracket

- Easy to fold
- For drop leaf up to 600 mm
- Load capacity up to 140 kg
- Material for harsh conditions
- Elegant and compact design

Material: Aluminum (AA6061)/Stainless steel (AISI304)

Treatment: Natural anodized

Hints how to choose Rakego support:

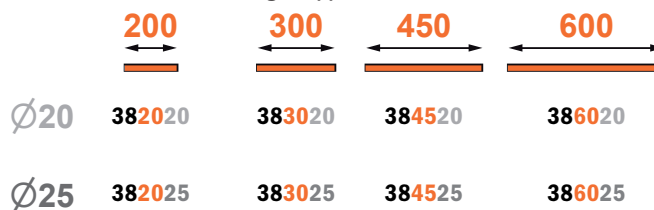

Art Nr	A = mm	B = mm	C = mm	P1 (kg)	P2 (kg)	
382020	23-30	150	14	60	30	TOPLICHT Art-Nr. 4428-150
382025	28-30	161	15	70	35	TOPLICHT Art-Nr.
383020	23-35	247	44	60	30	TOPLICHT Art-Nr. 4428-247
383025	28-39	252	45	95	55	TOPLICHT Art-Nr. 4428-252
384520	23-46	392	86	60	30	TOPLICHT Art-Nr. 4428-392
384525	28-50	402	87	120	60	TOPLICHT Art-Nr. 4428-402
386020	23-40	544	136	60	30	TOPLICHT Art-Nr. 4428-544
386025	28-40	549	137	140	80	TOPLICHT Art-Nr. 4428-549

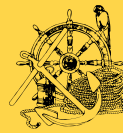

2014-09-03



To fold:

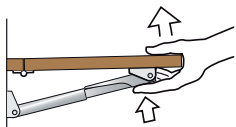

1.

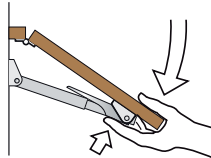

2.



3.

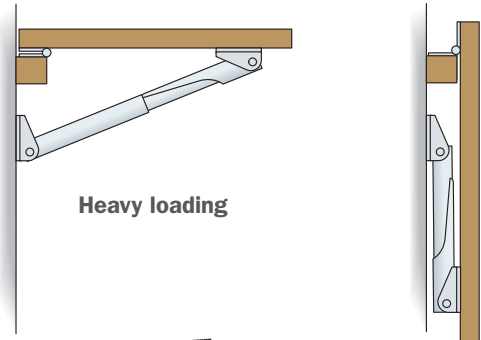

» See Rakego movie on YouTube

Some examples , the possibilities are unlimited:

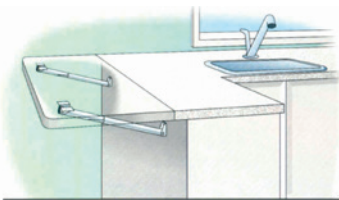

Extra working space in the kitchen

Size of the bench $\approx 130 \times 70$ cm.
Mount 2 pcs Rakego 386025.



Kitchen table, writing desk or sitting room table.

Size of the section $\approx 80 \times 70$ cm.
Mount 1 pcs Rakego 384525.

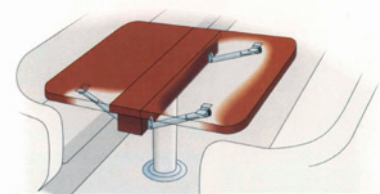

A table for boat, trailer or camper.

Left section size $\approx 120 \times 28$ cm.
Mount 2 pcs Rakego 382020.
Right section size $\approx 120 \times 40$ cm.
Mount 2 pcs Rakego 383020.

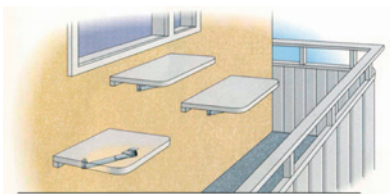

Balcony table and chairs.

Size of the table $\approx 50 \times 50$ cm.
Mount 1 pcs Rakego 384520.
Size of the chair $\approx 50 \times 50$ cm.
Mount 1 pcs Rakego 383025.

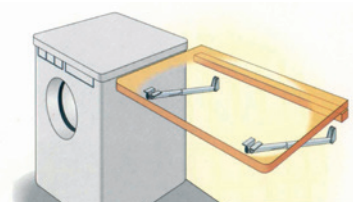

Extra space in the laundry room.

Size of the bench $\approx 80 \times 60$ cm.
Mount 2 pcs Rakego 386020.

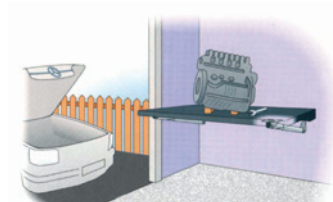

Work bench in the garage, packaging bench in the workshop.

Size of the bench $\approx 150 \times 60$ cm.
Mount 2 pcs Rakego 386025.